

G-8071-LM31E1-T

SOLAR Series

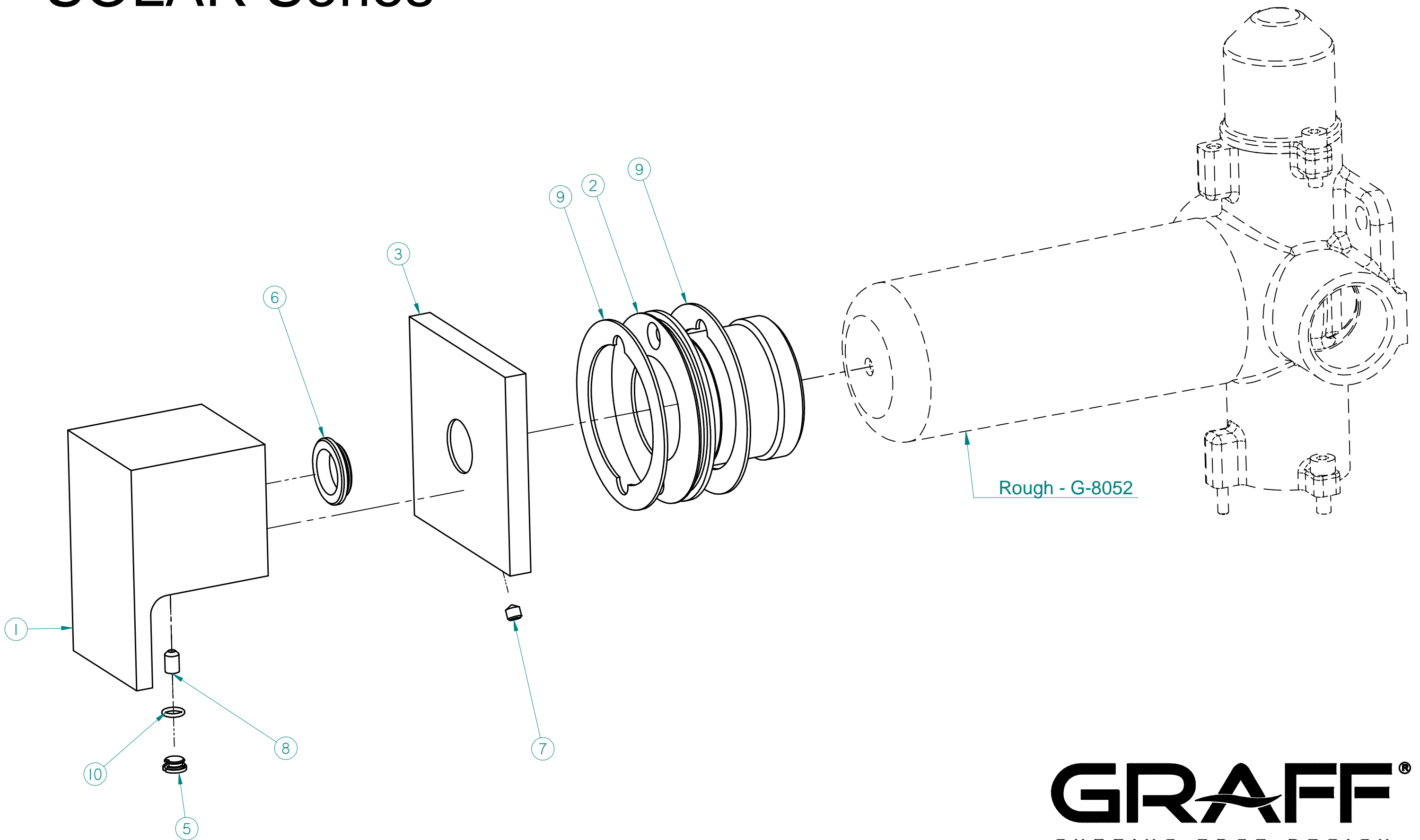

GRAFF[®]
CUTTING EDGE DESIGN