

# G-8071-SH1-T

## 2-way Diverter Valve - Trim - M-Series

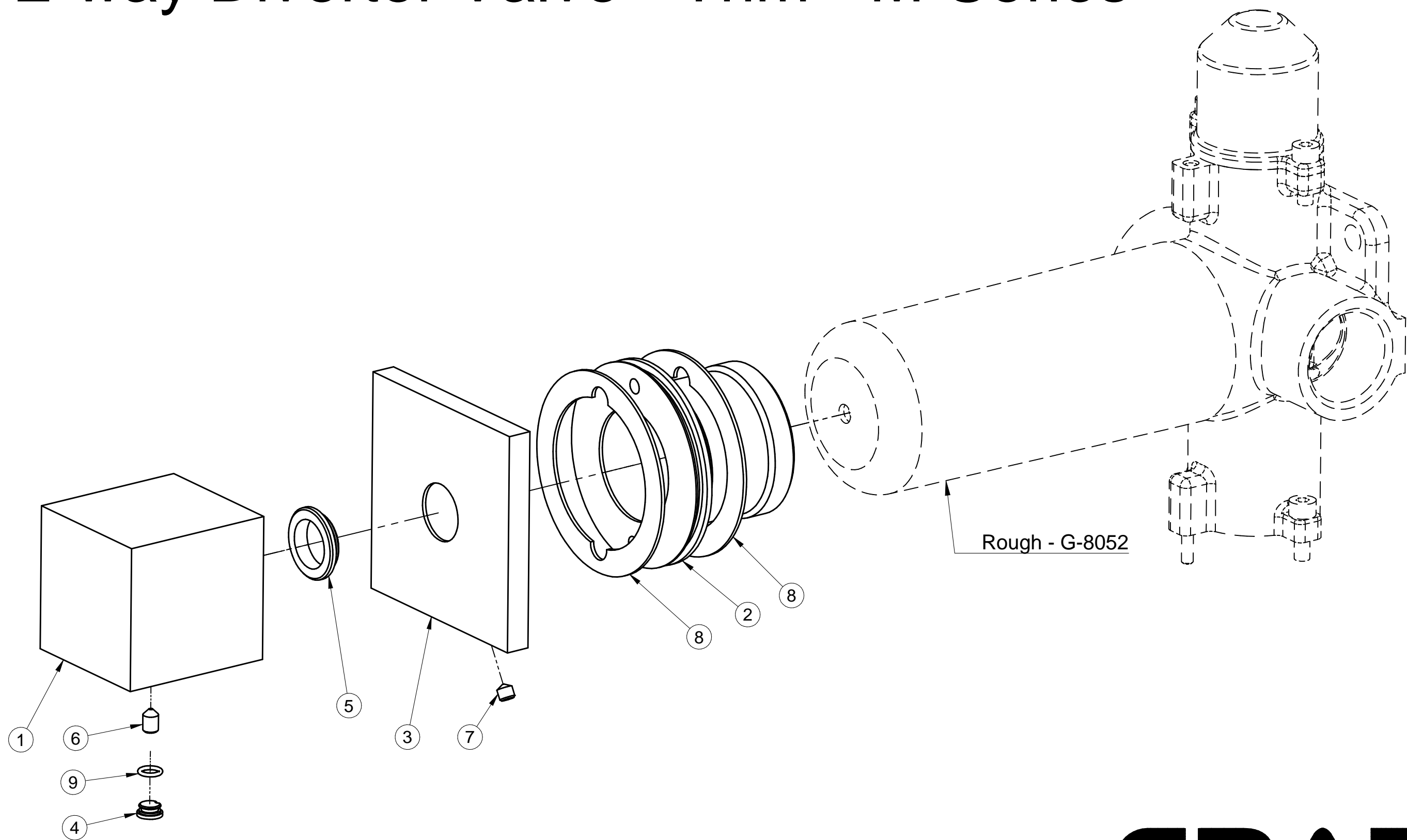

**GRAFF**<sup>®</sup>  
CUTTING EDGE DESIGN