

G-8072-LM31E1-T

SOLAR Series

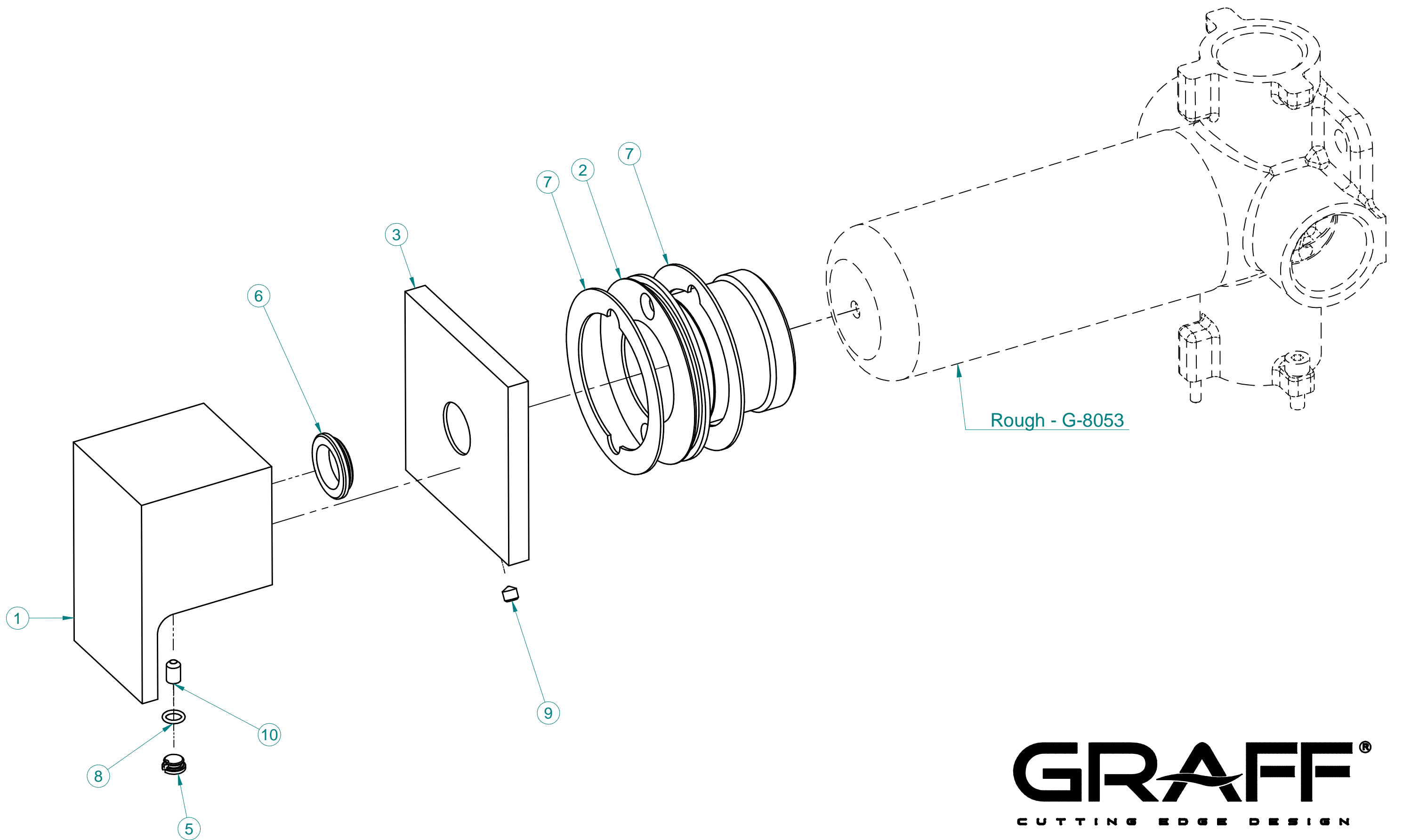

GRAFF[®]
CUTTING EDGE DESIGN