

# G-8179H-1L3C-T

## Finezza Due Series

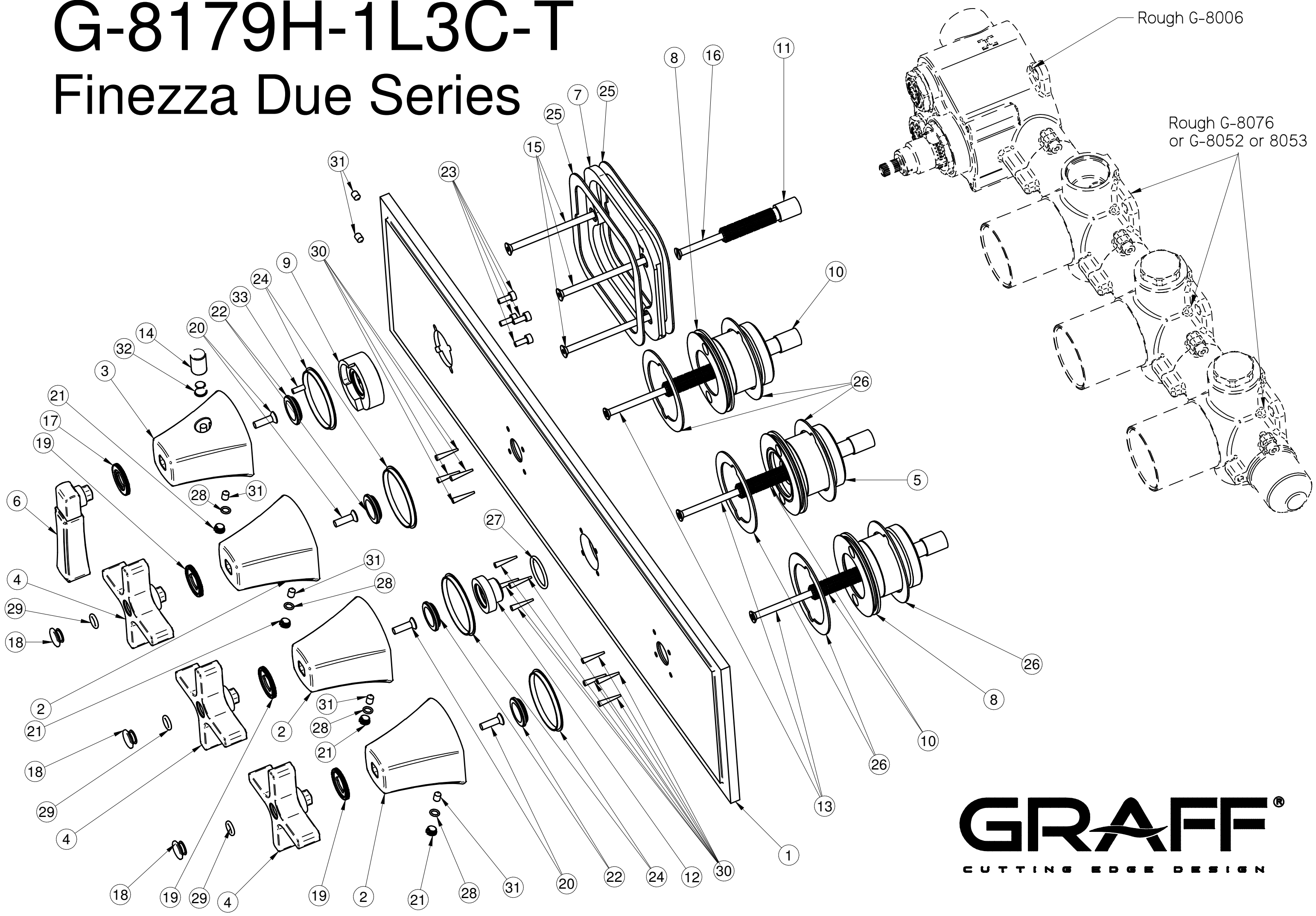

**GRAFF**<sup>®</sup>  
CUTTING EDGE DESIGN