

G-8179H-3C1L-T

Finezza Due Series

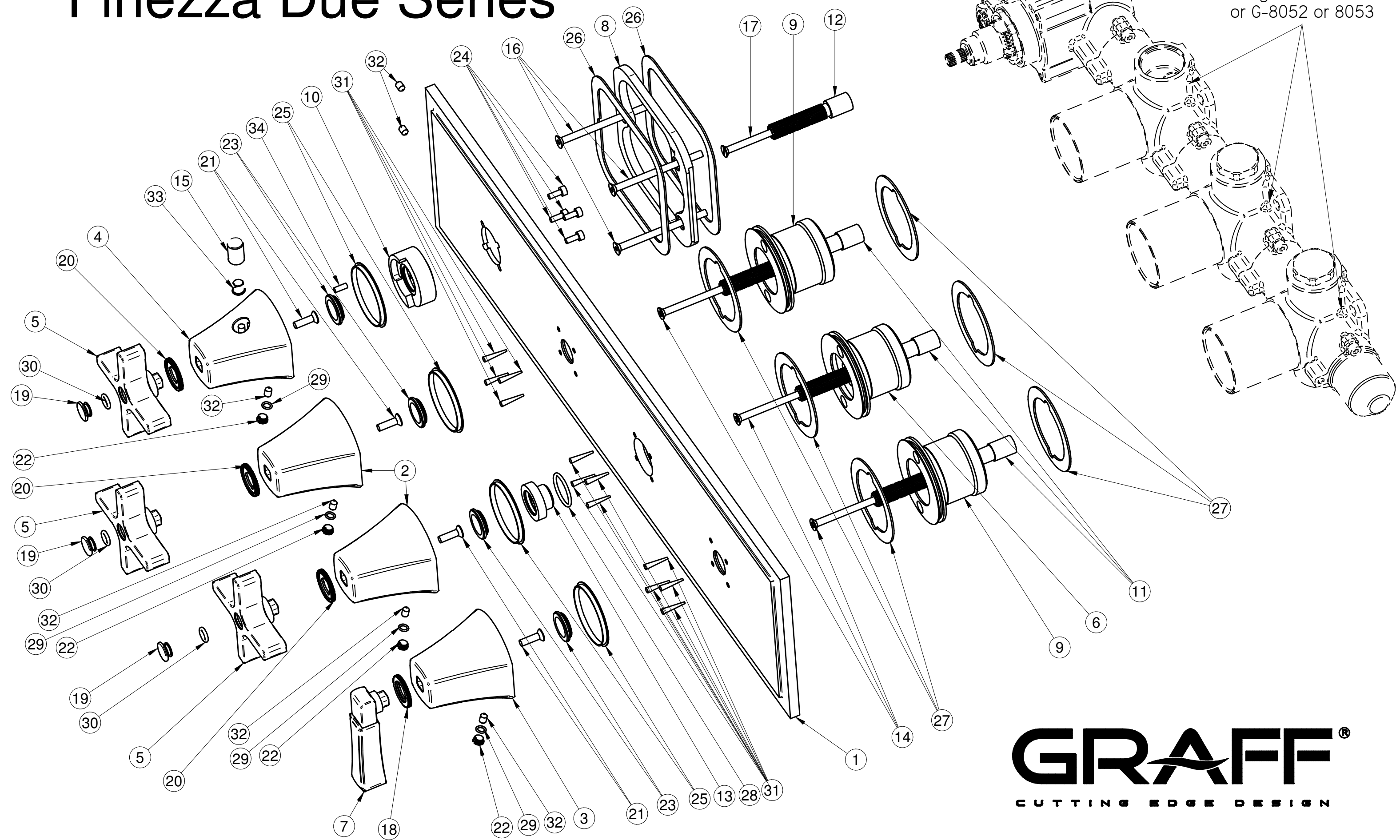

GRAFF[®]
CUTTING EDGE DESIGN