

G-9128

M.E Series

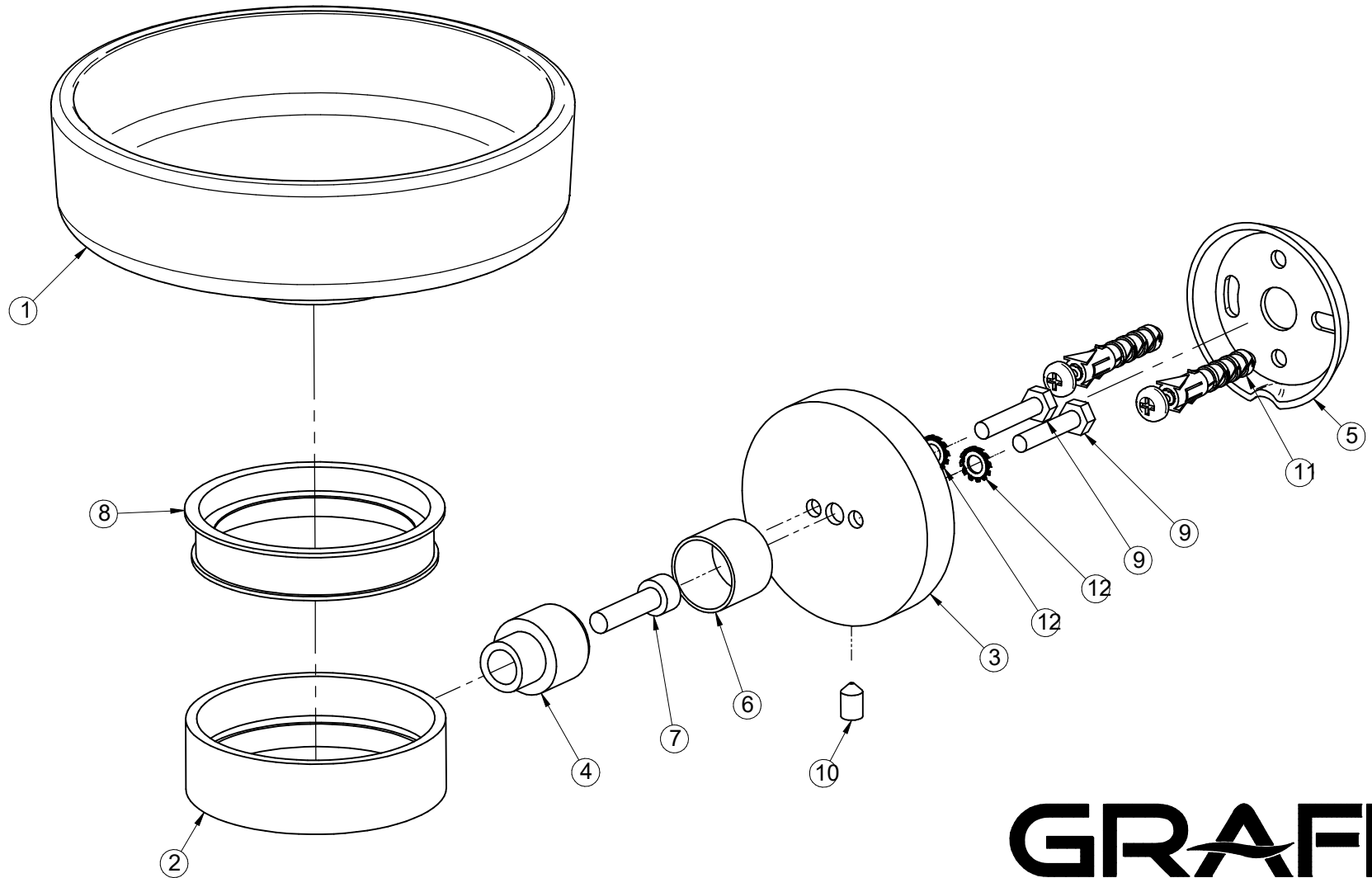

GRAFF[®]
Art of Bath